

UPLAY TODAY™

PLAY SYSTEMS

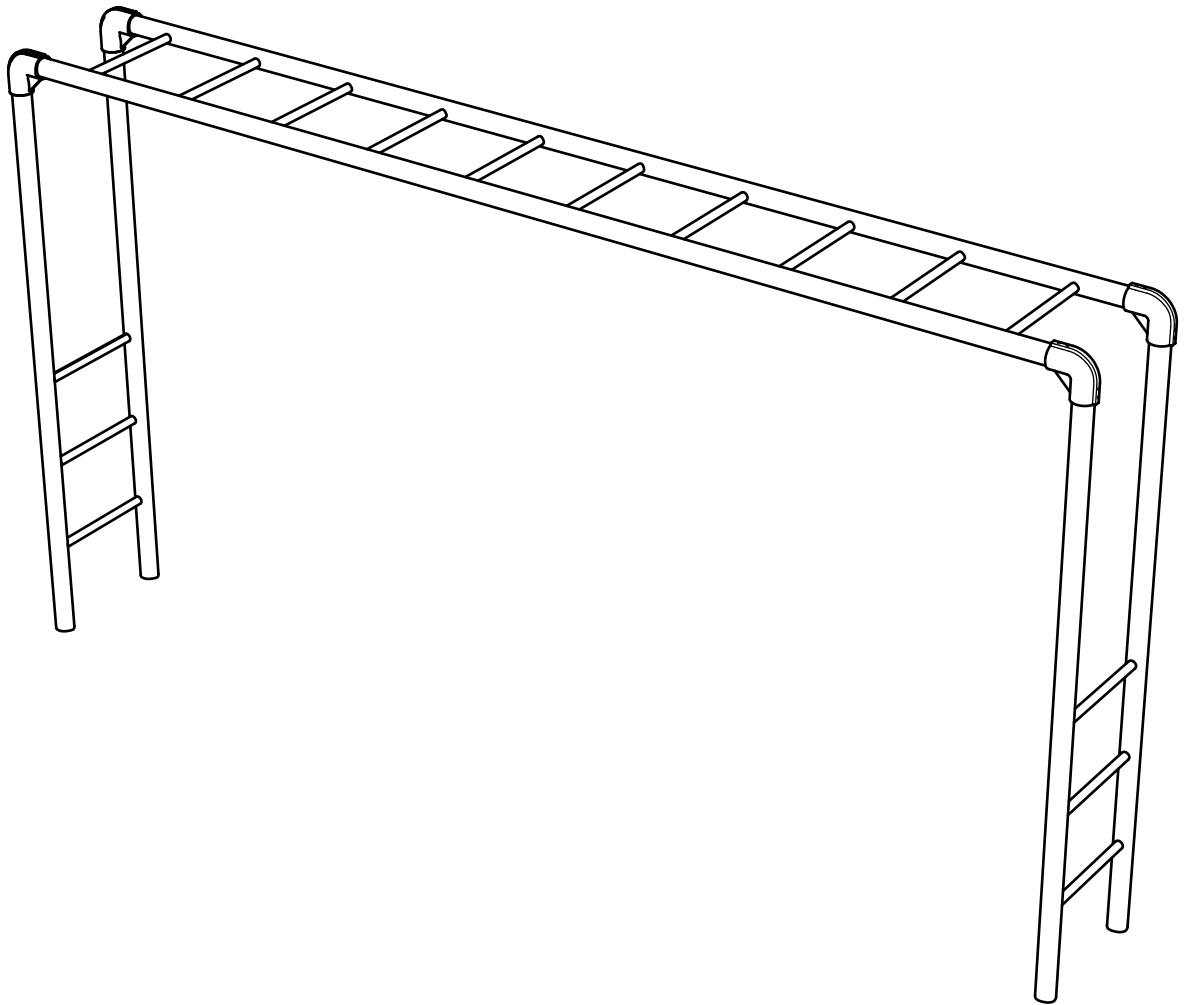

MODEL # PHLAD

Horizontal Ladder

INSTALLATION INSTRUCTIONS

UPLAYTODAY PLAY SYSTEMS • 800.458.5872 • www.uplaytoday.com

GROUND PLAN

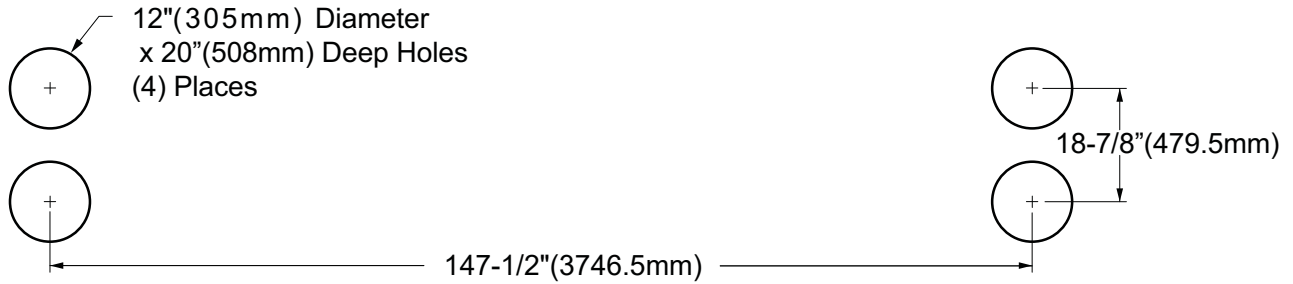

Concrete Required : Approx. .25 Cubic Yards (.15 Cubic Meters)

NOTE: Suggested Min. concrete rating: 3000PSI

NOTE:

Hole depths indicated on all ground plans are measured from the finished surface. See *Footing Details*.

All Footer dimensions are based on level finished surface.

Dimensioned to top of brick or equivalent

FOOTING DETAIL

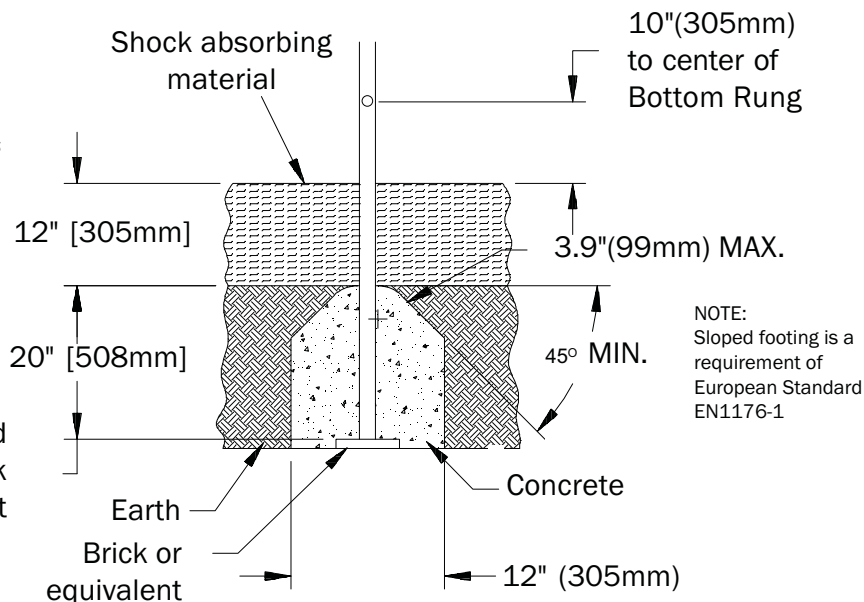

SPECIFICATONS:

Horizontal Ladder Frame and Vertical Ladder Frame are fabricated from 2-3/8" O.D. 10 gauge galvanized steel tubing with 1-5/16" O.D., 14 gauge steel tubing rungs. Weld assembly shall be powder coated after fabrication.

Steel tubing rungs are 1-5/16" O.D. 14 gauge steel tubing and powder coated after fabrication. Weight: 220 lbs.

MAINTENANCE:

Periodically check hardware for tightness and tighten as necessary. Always check all parts for breakage or wear, and immediately put equipment out of service until any faulty parts found are repaired or replaced. Also check all metal parts for rust, paint loss and touch-up paint as necessary with paint. Check welded areas and verify integrity. Check periodically resilient surfacing for appropriate depth and remove extraneous materials that could cause injury, infection or disease. Maintain detailed installation, inspection, maintenance and repair records for public-use playground equipment.

INSTALLATION INSTRUCTIONS

Parts List			
Letter	Description	Quantity	Part Number
A	Horizontal Ladder	1	02-01-0008
B	Vertical Ladder Legs	2	02-01-0007
C	Elbow w/ set screws	4	55-1029

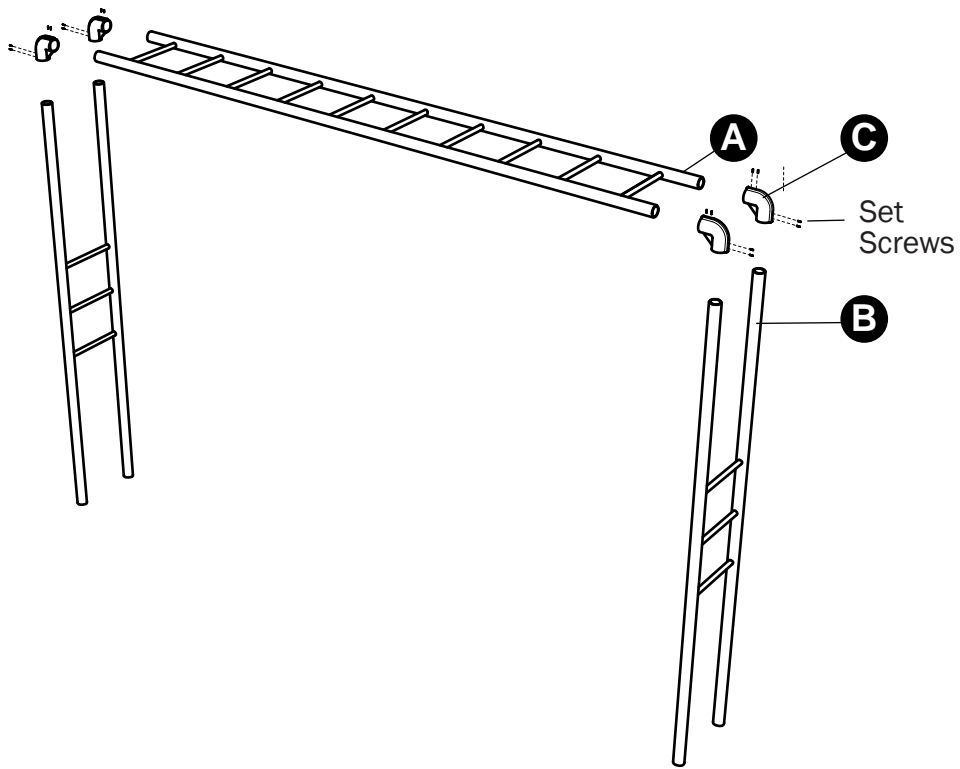

ASSEMBLY INSTRUCTIONS:

1. Dig footing holes at locations and depths indicated on ground plan.
2. Connect Horizontal Ladder(A) to Vertical Ladders(B) using Cast Iron Elbow w/ Set Screws(C).
3. Secure Elbow(C) to Ladders(A,B) using 3/8" set screws.
4. Set assembly into holes and check for plumb and level.
5. Pour concrete footing with within 4" to the top of the hole and taper way from the support post to allow water drainage. Allow to cure at least 48 hours before use.